



▼ Charaterastic

Illuminate Your Space with Confidence:

1. Sleek & Durable Design: Modern industrial aesthetic with a high-strength, impact-resistant aluminum body ensures a long-lasting impression.
2. Advanced Thermal Management: Isolated dual-cavity design and independent radiator keep LEDs cool for optimal performance and longevity.
3. Exceptional Efficiency & Reliability: High-voltage isolated drive prevents flickering and damage from voltage fluctuations, while high-efficiency LEDs provide superior brightness, energy savings, and slow brightness decay over time.

- Pole mounting or wall mounting
- Working temperature is -50°C to 70°C



IP66

▼ Application

I ➤ Outdoor Occasion such as stadium/sport, wharve, airport and etc.

▼ "Non-dim/dim" and "Mono/Tunable white/chromatic" is available, Pls confirm before ordering.



Mono

ON/OFF 0-10V DALI

▼ Family Matrix (Four basic combinations)

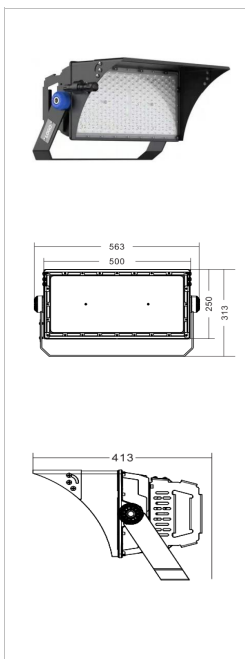

SL-01A-500W

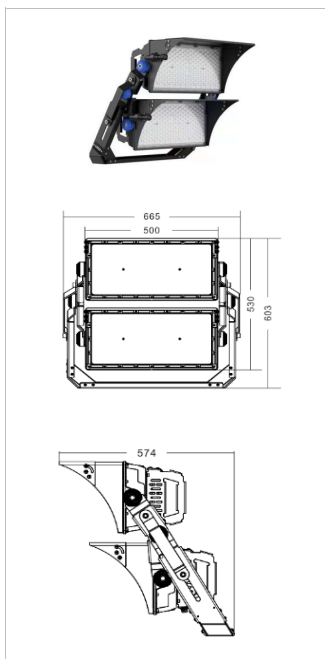

SL-01B-1000W

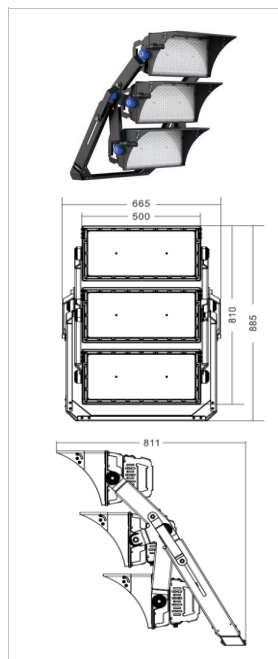

SL-01C-1500W

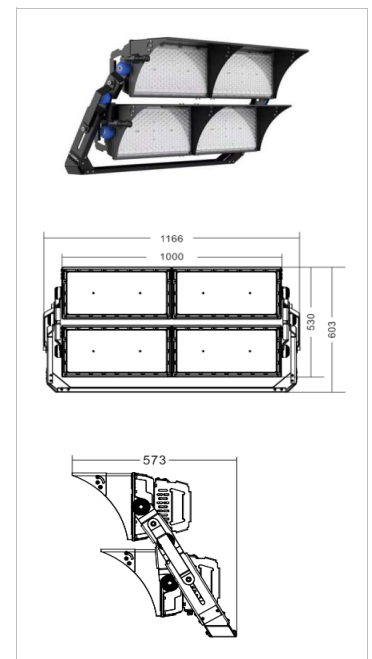

SL-01D-2000W

▼ Simulation

▼ Project



▼ Technical Data (full sery)

Model	SIZE (mm)	POWER (W/M)	CRI	CCT (K)	LUMINOUS	VOLT	Control	Beam Angle	PF	N.W
SL-01A-500	563X413X313mm	500 W	>80	2700-5700K	70000 LM	100-277V AC	On/Off or Dim	15/30/45/60/120°	95	13.50 kgs
SL-01B-1000	665X574X603mm	1000 W	>80	2700-5700K	140000 LM	100-277V AC	On/Off or Dim	15/30/45/60/120°	95	25.80 kgs
SL-01C-1500	665X811X885mm	1500 W	>80	2700-5700K	210000 LM	100-277V AC	On/Off or Dim	15/30/45/60/120°	95	40.50 kgs
SL-01D-2000	1166X573X603mm	2000 W	>80	2700-5700K	280000 LM	100-277V AC	On/Off or Dim	15/30/45/60/120°	95	48.50 kgs

I + Notes:

1. Finish: Black, and customized RAL available
2. It can be changed into 4 basic combinations from 500W-2000W.

▼ Photometric curve

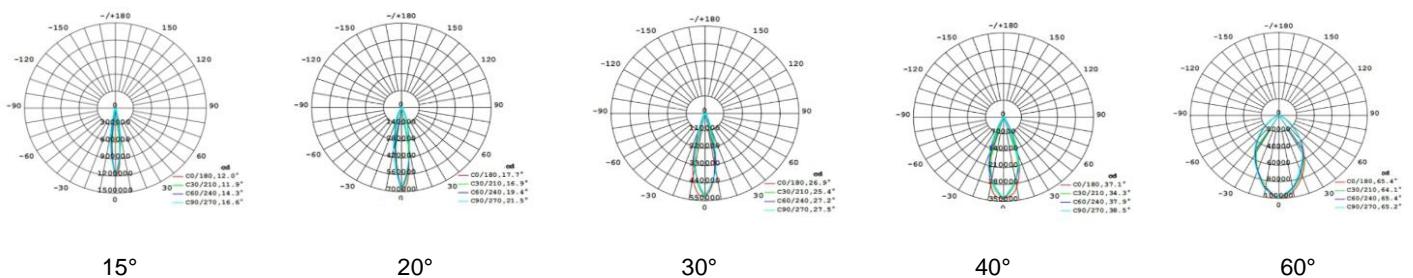

▼ Naming scheme

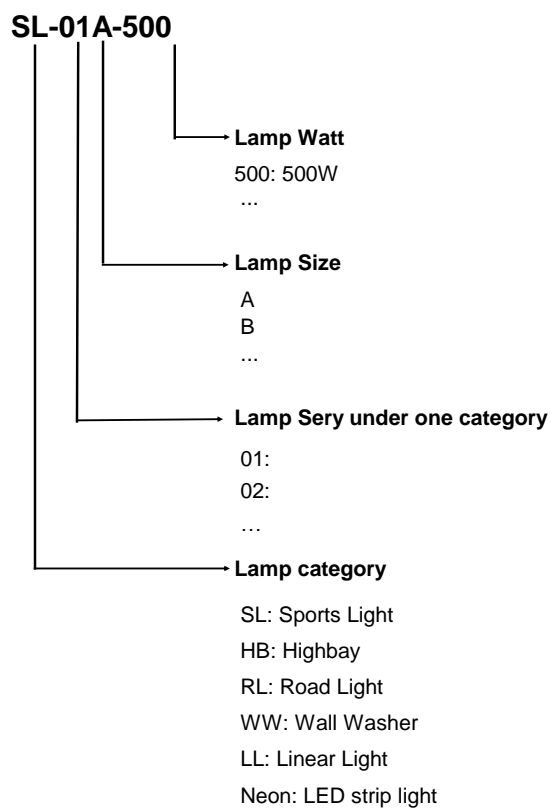

▼ Charaterastic

Illuminate Your Space with Confidence:



- 1.Sleek & Durable Design: Modern industrial aesthetic with a high-strength, impact-resistant aluminum body ensures a long-lasting impression.
- 2.Advanced Thermal Management: Isolated dual-cavity design and independent radiator keep LEDs cool for optimal performance and longevity.
- 3.Exceptional Efficiency & Reliability: High-voltage isolated drive prevents flickering and damage from voltage fluctuations, while high-efficiency LEDs provide superior brightness, energy savings, and slow brightness decay over time.

- + Pole mounting or wall mounting
- + Working temperature is -50°C to 70°C

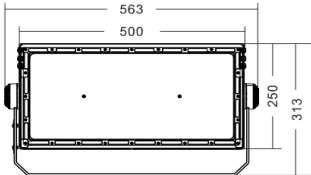

▼ Application

- I + Outdoor Occasion such as stadium/sport, wharve, airport and etc.

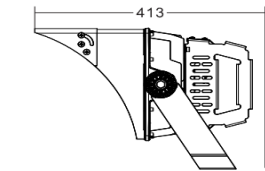

▼ "Non-dim/dim" and "Mono/Tunable white/chromatic" is available, Pls confirm before ordering.

ON/OFF 0-10V DALI
 Mono

▼ Technical Data

Model	SIZE (mm)	POWER (W/M)	CRI	CCT (K)	LUMINOUS	VOLT	Control	Beam Angle	PF	N.W
SL-01A	563X413X313mm	500 W	>80	2700-5700K	72500 LM	100-277V AC	On/Off or Dim	15/30/45/60/120°	> 95	13.50 kgs

- I + Notes:
1. Finish: Black, and customized RAL available
 2. It can be changed into 4 basic combinations from 500W-2000W.

▼ Simulation



▼ Project

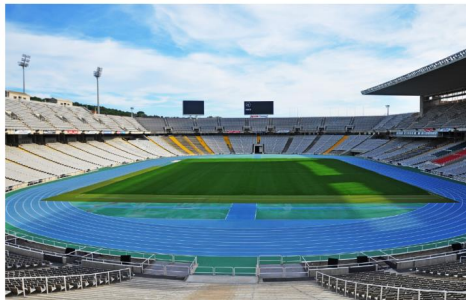

▼ Photometric curve

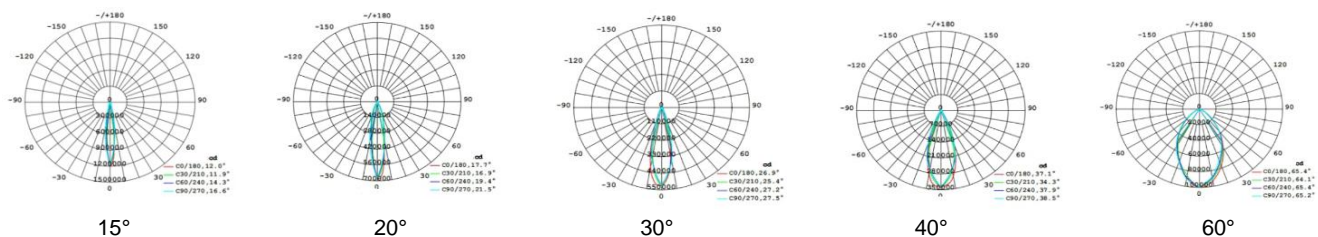



▼ Charaterastic

Illuminate Your Space with Confidence:

- 1.Sleek & Durable Design: Modern industrial aesthetic with a high-strength, impact-resistant aluminum body ensures a long-lasting impression.
- 2.Advanced Thermal Management: Isolated dual-cavity design and independent radiator keep LEDs cool for optimal performance and longevity.
- 3.Exceptional Efficiency & Reliability: High-voltage isolated drive prevents flickering and damage from voltage fluctuations, while high-efficiency LEDs provide superior brightness, energy savings, and slow brightness decay over time.

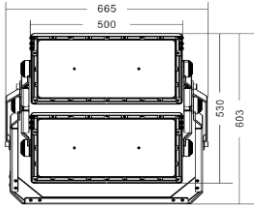

IP66

- + Pole mounting or wall mounting
- + Working temperature is -50°C to 70°C

▼ Application

I + Outdoor Occasion such as stadium/sport, wharve, airport and etc.

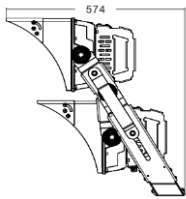

▼ "Non-dim/dim" and "Mono/Tunable white/chromatic" is available, Pls confirm before ordering.



ON/OFF 0-10V DALI

▼ Technical Data

Model	SIZE (mm)	POWER (W/M)	CRI	CCT (K)	LUMINOUS	VOLT	Control	Beam Angle	PF	N.W
SL-01B	665X574X603mm	1000 W	>80	2700-5700K	145000 LM	100-277V AC	On/Off or Dim	15/30/45/60/120°	> 95	25.80 kgs

- I + Notes:
1. Finish: Black, and customized RAL available
 2. It can be changed into 4 basic combinations from 500W-2000W.

▼ Simulation



▼ Project

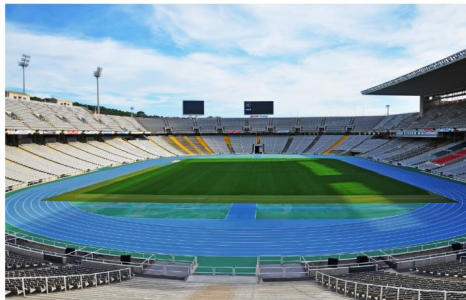

▼ Photometric curve

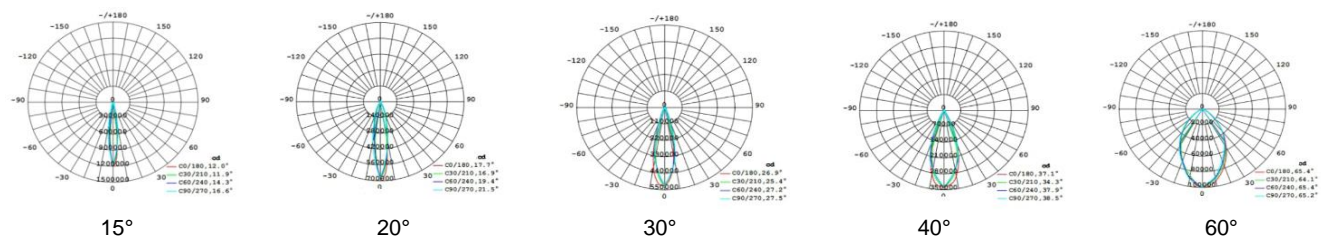

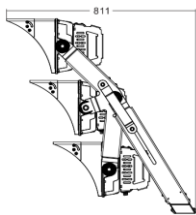
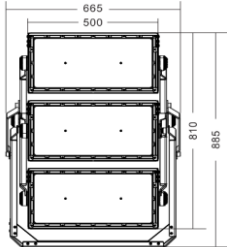

IP66

- + Pole mounting or wall mounting
- + Working temperature is -50°C to 70°C

▼ Charaterastic

Illuminate Your Space with Confidence:

1. Sleek & Durable Design: Modern industrial aesthetic with a high-strength, impact-resistant aluminum body ensures a long-lasting impression.
2. Advanced Thermal Management: Isolated dual-cavity design and independent radiator keep LEDs cool for optimal performance and longevity.
3. Exceptional Efficiency & Reliability: High-voltage isolated drive prevents flickering and damage from voltage fluctuations, while high-efficiency LEDs provide superior brightness, energy savings, and slow brightness decay over time.

▼ Application

I + Outdoor Occasion such as stadium/sport, wharve, airport and etc.

▼ "Non-dim/dim" and "Mono/Tunable white/chromatic" is available, PIs confirm before ordering.



ON/OFF 0-10V DALI

▼ Technical Data

Model	SIZE (mm)	POWER (W/M)	CRI	CCT (K)	LUMINOUS	VOLT	Control	Beam Angle	PF	N.W
SL-01C	665X811X885mm	1500 W	>80	2700-5700K	217500 LM	100-277V AC	On/Off or Dim	15/30/45/60/120°	> 95	40.50 kgs

- I + Notes:
1. Finish: Black, and customized RAL available
 2. It can be changed into 4 basic combinations from 500W-2000W.

▼ Simulation



▼ Project

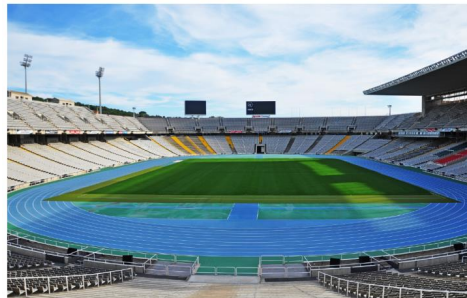

▼ Photometric curve

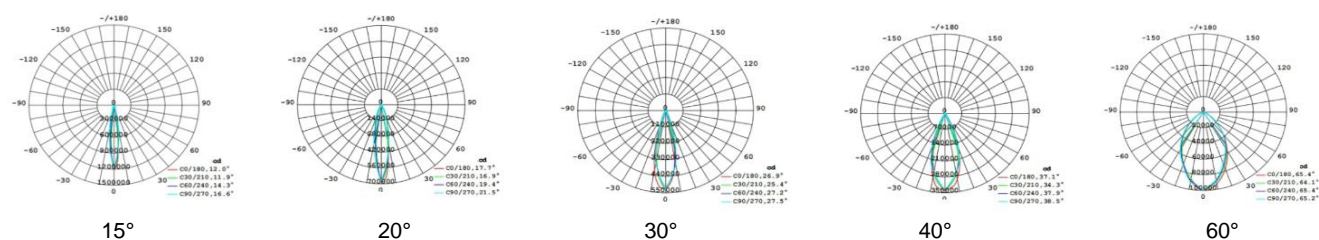

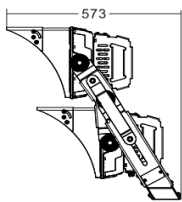
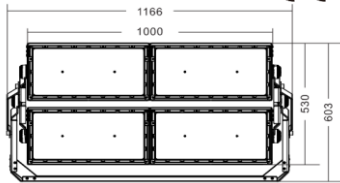

Charaterastic

Illuminate Your Space with Confidence:

- 1.Sleek & Durable Design: Modern industrial aesthetic with a high-strength, impact-resistant aluminum body ensures a long-lasting impression.
- 2.Advanced Thermal Management: Isolated dual-cavity design and independent radiator keep LEDs cool for optimal performance and longevity.
- 3.Exceptional Efficiency & Reliability: High-voltage isolated drive prevents flickering and damage from voltage fluctuations, while high-efficiency LEDs provide superior brightness, energy savings, and slow brightness decay over time.

- + Pole mounting or wall mounting
- + Working temperature is -50°C to 70°C

Application

- I + Outdoor Occasion such as stadium/sport, wharve, airport and etc.

▼ "Non-dim/dim" and "Mono/Tunable white/chromatic" is available, Pls confirm before ordering.

Mono ON/OFF 0-10V DALI

Technical Data

Model	SIZE (mm)	POWER (W/M)	CRI	CCT (K)	LUMINOUS	VOLT	Control	Beam Angle	PF	N.W
SL-01D	1166X573X603mm	2000 W	>80	2700-5700K	290000 LM	100-277V AC	On/Off or Dim	15/30/45/60/120°	> 95	48.50 kgs

- I + Notes:
1. Finish: Black, and customized RAL available
 2. It can be changed into 4 basic combinations from 500W-2000W.

Simulation



Project

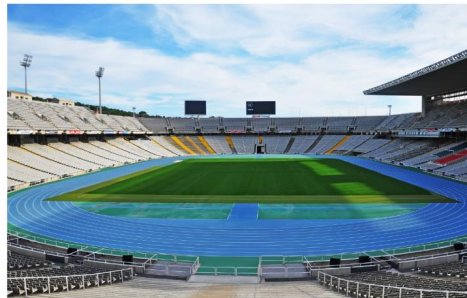

Photometric curve

